

Pictorial Index

Modular Fixture Bases

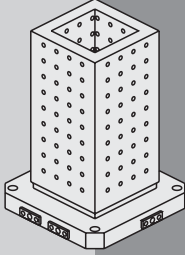

RECTANGULAR GRID PLATES

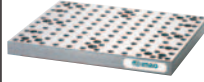

Page 14

Product Family
BJ010(Standard&Heavy)

SQUARE GRID PLATES



Page 17

Product Family
BJ040(Standard&Heavy)

ANGLE GRID PLATES



Page 18

Product Family
BJ050(Standard&Heavy)

TWO-SIDED GRID BLOCKS



Page 20

Product Family
BJ060/BJ061(Standard&Heavy)

FOUR-SIDED GRID BLOCKS



Page 22

Product Family
BJ070/BJ071(Standard&Heavy)

RISER BLOCKS



Page 24

Product Family
BJ090(Standard&Heavy)

COMPACT RISER BLOCKS



Page 25

Product Family
BJ091(Standard&Heavy)

RISER BLOCKS (Rough-finish Machined)

NEW



Page 26

Product Family
BJ092

Blank Fixture Bases

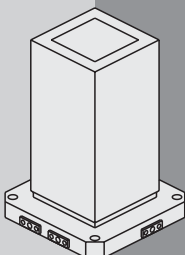

ANGLE BLANK PLATES



Page 27

Product Family
BJ050

TWO-SIDED BLANK BLOCKS



Page 28

Product Family
BJ060/BJ061

Modular
Fixture Bases

Blank
Fixture Bases

Quick-Change
Fixture Bases

Standard
Fixture Parts

Modular
Fixture Parts

One-Touch
Clamps

FOUR-SIDED BLANK BLOCKS



Page **29**

Product Family
BJ070/BJ071

Quick-Change Fixture Bases

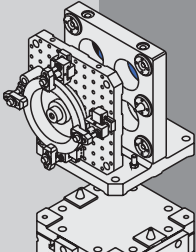

FLEX BASE PLATES



Page **34**

Product Family
FJ01-N

FLEX ANGLE PLATES



Page **36**

Product Family
FJ05

FLEX GRID FIXTURE PLATES

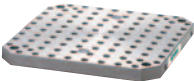

Page **38**

Product Family
FJ10(Standard&Heavy)

FLEX BLANK FIXTURE PLATES

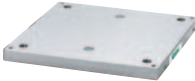

Page **40**

Product Family
FJ12

Standard Fixture Parts

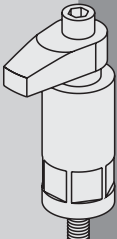

TOE CLAMPS



Page **42**

Product Family
CP106

SIDE CLAMPS



Page **43**

Product Family
CP107

Modular
Fixture Bases

Blank
Fixture Bases

Quick-Change
Fixture Bases

Standard
Fixture Parts

Modular
Fixture Parts

One-Touch
Clamps

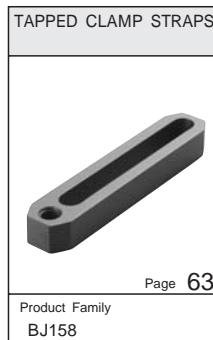
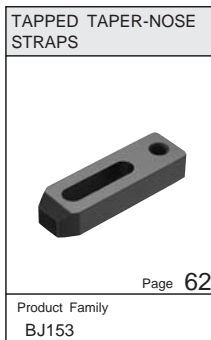
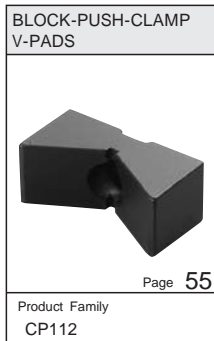
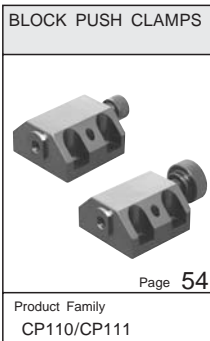
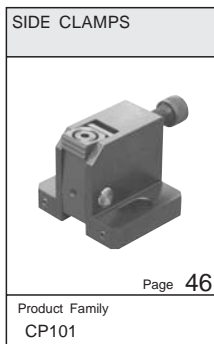
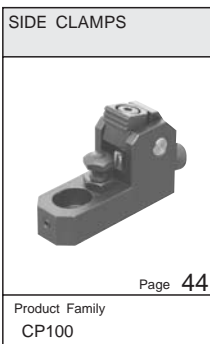

WORK GUIDE ANGLES
NEW 
Page 64
Product Family BJ840

WORK GUIDE PINS
NEW 
Page 65
Product Family BJ841

ADJUSTABLE STOPS

Page 66
Product Family BJ210

ADJUSTABLE MINIATURE STOPS

Page 67
Product Family BJ211

SCREW STOP BUTTONS

Page 68
Product Family BJ214

SUPPORT CYLINDERS

Page 69
Product Family BJ300

WORK SUPPORT CYLINDERS

Page 70
Product Family BJ351

REMOTE-CONTROL UNITS

Page 72
Product Family BJ650

REMOTE-CONTROL EXTENSION BLOCKS

Page 73
Product Family BJ651

WORK SUPPORTS

Page 74
Product Family BJ350

COMPACT WORK SUPPORTS

Page 75
Product Family BJ360

WORK SUPPORTS WITH CAM HANDLE
NEW 
Page 76
Product Family BJ352

EXTENDABLE WORK SUPPORTS

Page 78
Product Family CP300

SCREW JACKS

Page 80
Product Family BJ330

SCREW-JACK TIP

Page 80
Product Family BJ733

MINIATURE JACKS

Page 81
Product Family BJ331

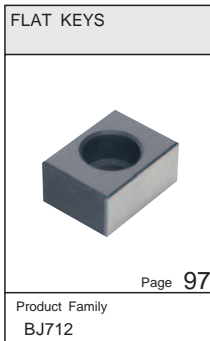

FLANGE NUTS



Page102

Product Family
BJ740

STUDS



Page103

Product Family
BJ745

SOCKET TOGGLE SCREWS



Page104

Product Family
BJ746

SPRING SUPPORTS



Page105

Product Family
BJ747

CLAMP SCREWS



Page106

Product Family
BJ748

T-SLOT NUTS



Page107

Product Family
BJ749

Modular Fixture Parts

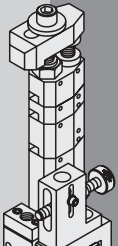

FLEX STARTER KIT A

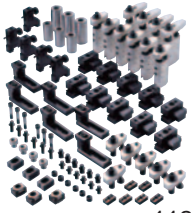

Page112

Product Family
FJ-KIT-A

FLEX STARTER KIT B



Page114

Product Family
FJ-KIT-B

FLEX STARTER KIT C



Page116

Product Family
FJ-KIT-C

SLIDING UNITS



Page118

Product Family
FJ20

REPLACEABLE SLIDE BASES



Page120

Product Family
FJ21

CLAMP ASSEMBLIES



Page122

Product Family
FJ30

HIGH-RISE CLAMP
ASSEMBLIES

Page123

Product Family
FJ40

QUICK-LOCK RISERS



Page124

Product Family
FJ41QUICK-LOCK BUTTONS
QUICK-LOCK SCREWS

Page125

Product Family
FJ42ADJUSTABLE SWIVEL
STOPS

Page127

Product Family
FJ50

OK-VISE CLAMPS

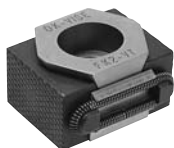

Page128

Product Family
DK2.FK2

SIDE STOPS



Page129

Product Family
FJ51

LOCATING ADAPTORS



Page130

Product Family
FJ55

RISER PADS



Page130

Product Family
FJ60

ROUND ADAPTORS



Page131

Product Family
FJ70

SUPPORT CYLINDERS



Page132

Product Family
BJ300

SCREW JACKS



Page132

Product Family
BJ330

SCREW-JACK TIP



Page133

Product Family
BJ733

LOCATING CYLINDERS



Page134

Product Family
BJ400LOCATING SCREWS
(Accurate)

Page135

Product Family
BJ701

One-Touch Clamps

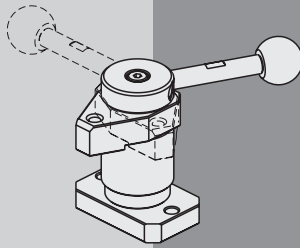

PULL CLAMPS(Standard)



Page138

Product Family
QLPD

CLAMPING PIN(Standard)



Page140

Product Family
QLPD-X

Modular
Fixture Bases

Blank
Fixture Bases

Quick-Change
Fixture Bases

Standard
Fixture Parts

Modular
Fixture Parts

One-Touch
Clamps

CLAMPING SCREWS (Standard)



Page141

Product Family
QLPD-M

PULL-CLAMP(Std.) MOUNTING PLATES



Page141

Product Family
QLPD-P

PULL CLAMPS(Heavy)



Page142

Product Family
QLPDH

CLAMPING PINS(Heavy)



Page144

Product Family
QLPDH-X

CLAMPING SCREWS (Heavy)



Page145

Product Family
QLPDH-M

PULL-CLAMP(Heavy) MOUNTING PLATES



Page145

Product Family
QLPDH-P

SWING CLAMPS(Mini)

NEW



Page146

Product Family
QLSWC

SWING CLAMPS(Mini) WITH CAM HANDLE

NEW



Page148

Product Family
QLSWC

SWING CLAMPS(Mini) FOR TORQUE CONTROL

NEW



Page150

Product Family
QLSWC

SWING CLAMPS (Standard)



Page152

Product Family
QLSW

MACHINABLE CLAMP ARMS FOR STANDARD SWING CLAMPS



Page154

Product Family
QLSW-SH

SWING-CLAMP(Standard) MOUNTING PLATES



Page155

Product Family
QLSW-P

SWING CLAMPS(Heavy)



Page156

Product Family
QLSWH

**SWING-CLAMP(Heavy)
MOUNTING PLATES**



Page159

Product Family
QLSWH-P

**RETRACTABLE CLAMPS(Mini)
WITH CAM HANDLE**

NEW



Page162

Product Family
QLRE

**RETRACTABLE CLAMPS(Mini)
WITH ADJUSTABLE HANDLE**

NEW



Page164

Product Family
QLRE

SIDE CLAMPS(Standard)



Page166

Product Family
QLSC

PUSH CLAMPS(Standard)



Page168

Product Family
QLPU

**PUSH-CLAMP(Std.)
MOUNTING PLATES**



Page169

Product Family
QLPU-P

STANDARD HANDLES



Page170

Product Family
QLSL

**ADJUSTABLE-TORQUE
HANDLES**



Page172

Product Family
QLTL

CAM CLAMPS



Page175

Product Family
BJ161

CAM HANDLES

NEW



Page176

Product Family
QLCA

Alphabetical Index

A

ADJUSTABLE MINIATURE STOPS 67
 ADJUSTABLE SIDE CLAMPS 51
 ADJUSTABLE STOPS 66
 ADJUSTABLE SWIVEL STOPS 127
 ADJUSTABLE TOE CLAMPS 50
 ADJUSTABLE-TORQUE HANDLES 172
 ANGLE BLANK PLATES 27
 ANGLE GRID PLATES 18

B

BLOCK PUSH CLAMPS 54
 BLOCK-PUSH-CLAMP V-PADS 55

C

CAM CLAMPS 175
 CAM HANDLES 176
 CLAMP ASSEMBLIES 122
 CLAMP RESTS 101
 CLAMP SCREWS 106
 CLAMPING PINS (Heavy) 144
 CLAMPING PINS (Standard) 140
 CLAMPING SCREWS (Heavy) 145
 CLAMPING SCREWS (Standard) 141
 COMPACT RISER BLOCKS 25
 COMPACT WORK SUPPORTS 75
 CONTACT BOLTS 100

E

EXTENDABLE WORK LOCATORS 92
 EXTENDABLE WORK SUPPORTS 78

F

FLANGE NUTS 102
 FLAT KEYS 97
 FLEX ANGLE PLATES 36
 FLEX BASE PLATES 34
 FLEX BLANK FIXTURE PLATES 40
 FLEX GRID FIXTURE PLATES 38
 FLEX STARTER KIT A 112
 FLEX STARTER KIT B 114
 FLEX STARTER KIT C 116
 FOUR-SIDED BLANK BLOCKS 29
 FOUR-SIDED GRID BLOCKS 22

H

HIGH-RISE CLAMP ASSEMBLIES 123

HOOK CLAMPS 56•60
 HOOK-CLAMP HOLDERS 58

J

JACK SCREWS 82

K

KNURLED KNOBS 59

L

LOCATING ADAPTORS 130
 LOCATING CYLINDERS 134
 LOCATING KEYS 96
 LOCATING SCREWS (Accurate) 95•135
 LOCATING SCREWS (Standard) 94

M

MACHINABLE CLAMP ARMS FOR STANDARD SWING CLAMPS 154
 MINIATURE JACKS 81

O

OK-VISE CLAMPS 128

P

PULL CLAMPS (Heavy) 142
 PULL-CLAMP (Heavy) MOUNTING PLATES 145
 PULL CLAMPS (Standard) 138
 PULL-CLAMP (Std.) MOUNTING PLATES 141
 PUSH CLAMPS (Standard) 168
 PUSH-CLAMP(Std.)MOUNTING PLATES 169

Q

QUICK-LOCK BUTTONS 125
 QUICK-LOCK RISERS 124
 QUICK-LOCK SCREWS, LONG 126
 QUICK-LOCK SCREWS, SHORT 125

R

RECTANGULAR GRID PLATES 14
 REMOTE-CONTROL EXTENSION BLOCKS 73
 REMOTE-CONTROL UNITS 72
 REPLACEABLE SLIDE BASES 120
 RETRACTABLE CLAMPS(Mini) WITH CAM HANDLE 162
 RETRACTABLE CLAMPS(Mini) WITH ADJUSTABLE HANDLE 164
 RISER BLOCKS 24

RISER BLOCKS(Rough-finish Machined) 26
 RISER CYLINDERS 84
 RISER PADS 130
 ROUND ADAPTORS 131

S

SCREW JACKS 80•132
 SCREW-JACK TIP 80•133
 SCREW STOP BUTTONS 68
 SERRATED ADAPTORS 49
 SIDE CLAMPS 43•44•46•53
 SIDE CLAMPS (STANDARD) 166
 SIDE STOPS 129
 SLIDING UNITS 118
 SMALL RISER CYLINDERS 85
 SMALL SCREW JACKS 83
 SOCKET TOGGLE SCREWS 104
 SPHERICAL FLANGE ASSEMBLIES 102
 SPRING-LOADED WORK LOCATORS 86
 SPRING SUPPORTS 105
 SQUARE GRID PLATES 17
 STANDARD HANDLES 170
 STUDS 103
 SUPPORT CYLINDERS 69•132
 SWING-CLAMP (Heavy) MOUNTING PLATES 159
 SWING-CLAMP (Standard) MOUNTING PLATES 155
 SWING CLAMPS (Heavy) 156
 SWING CLAMPS (Mini) 146
 SWING CLAMPS(Mini) FOR TORQUE CONTROL 150
 SWING CLAMPS(Mini) WITH CAM HANDLE 148
 SWING CLAMPS (Standard) 152
 SWIVEL CONTACT BOLTS 98

T

TAPPED CLAMP STRAPS 63
 TAPPED TAPER-NOSE STRAPS 62
 TOE CLAMPS 42•52
 TOGGLE PADS 99
 T-SLOT NUTS 107
 TWO-SIDED BLANK BLOCKS 28
 TWO-SIDED GRID BLOCKS 20

W

WORK GUIDE ANGLES 64
 WORK GUIDE PINS 65
 WIDE-JAW SIDE CLAMPS 48
 WORK LOCATORS 90
 WORK SUPPORT CYLINDERS 70
 WORK SUPPORTS 74
 WORK SUPPORTS WITH CAM HANDLE 76

Modular
Fixture Bases

Blank
Fixture Bases

Quick-Change
Fixture Bases

Standard
Fixture Parts

Modular
Fixture Parts

One-Touch
Clamps

Product Family Index

B

BJ010(Standard&Heavy)	14
BJ040(Standard&Heavy)	17
BJ050	27
BJ050(Standard&Heavy)	18
BJ060	28
BJ060(Standard&Heavy)	20
BJ061	28
BJ061(Standard&Heavy)	20
BJ070	29
BJ070(Standard&Heavy)	22
BJ071	29
BJ071(Standard&Heavy)	22
BJ090(Standard&Heavy)	24
BJ091(Standard&Heavy)	25
BJ092	26
BJ101	50
BJ102	51
BJ130	56
BJ131	60
BJ153	62
BJ158	63
BJ161	175
BJ210	66
BJ211	67
BJ214	68
BJ300	69•132
BJ330	80•132
BJ331	81
BJ332	82
BJ333	83
BJ350	74
BJ351	70
BJ352	76
BJ360	75
BJ400	134
BJ500	49
BJ530	58
BJ600	84
BJ601	85
BJ650	72
BJ651	73
BJ700	94
BJ701	95•135
BJ710	96
BJ712	97
BJ730	98
BJ731	99
BJ732	100
BJ733	80•133
BJ734	101
BJ739	102

BJ740	102
BJ745	103
BJ746	104
BJ747	105
BJ748	106
BJ749	107
BJ750	59
BJ840	64
BJ841	65

C

CP100	44
CP101	46
CP102	48
CP104	52
CP105	53
CP106	42
CP107	43
CP110	54
CP111	54
CP112	55
CP300	78
CP700	90
CP701	92
CP710	86

D

DK2	128
-----------	-----

F

FJ01-N	34
FJ05	36
FJ10(Standard&Heavy)	38
FJ12	40
FJ20	118
FJ21	120
FJ30	122
FJ40	123
FJ41	124
FJ42	125•126
FJ50	127
FJ51	129
FJ55	130
FJ60	130
FJ70	131
FJ-KIT-A	112
FJ-KIT-B	114
FJ-KIT-C	116
FK2	128

Q

QLCA	176
QLPD	138
QLPDH	142
QLPDH-M	145
QLPDH-P	145
QLPDH-X	144
QLPD-M	141
QLPD-P	141
QLPD-X	140
QLPU	168
QLPU-P	169
QLRE	162•164
QLSC	166
QLSL	170
QLSW	152
QLSWC	146•148•150
QLSWH	156
QLSWH-P	159
QLSW-P	155
QLSW-SH	154
QLTL	172

Modular
Fixture BasesBlank
Fixture BasesQuick-Change
Fixture BasesStandard
Fixture PartsModular
Fixture PartsOne-Touch
Clamps